

Gauge invariance

Reminder:

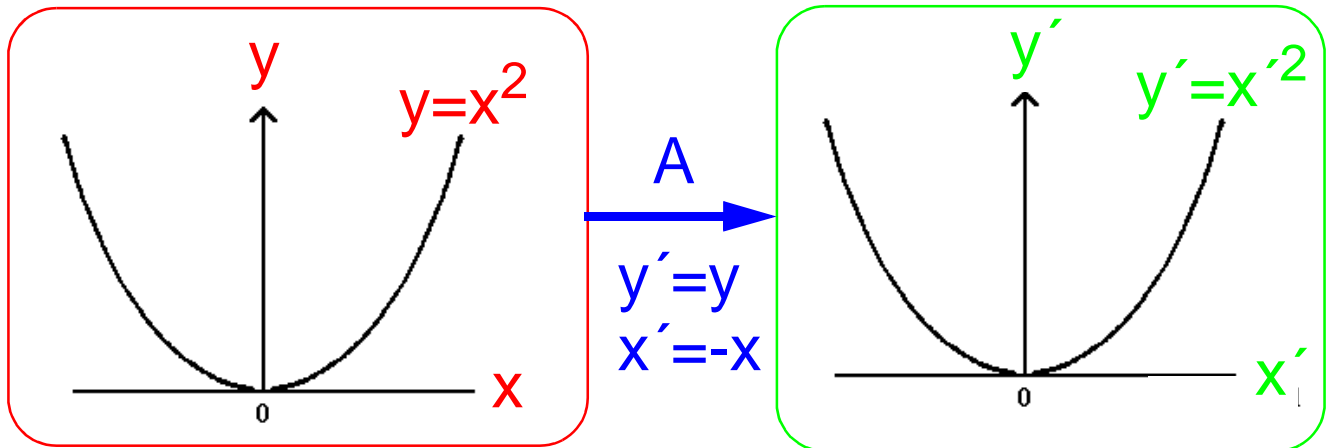

The equation $y=x^2$ is **symmetric** or **invariant** under the transformation **A** i.e. it looks the same before and after the transformation.

- Modern quantum field theories are *gauge invariant* theories i.e. they are theories where the main equations do not change when a gauge transformation is performed.
- By requiring that the theories are gauge invariant one can in fact deduce the various interactions.

What is a gauge transformation ?

There are several forms of gauge transformations corresponding to different interactions.

Example from non-relativistic electromagnetism:

Assume that we do not know the Schrödinger equation for electromagnetic interactions but we do know that it has to be invariant under a so-called **U(1)** phase transformation:

$$\psi(\vec{x}, t) \rightarrow \psi'(\vec{x}, t) = e^{iq\alpha(\vec{x}, t)} \psi(\vec{x}, t) \quad (118)$$

Here $\alpha(\vec{x}, t)$ is an arbitrary continuous function.

If a non-relativistic particle is free, then the equation of motion is the **free particle Schrödinger equation**:

$$i\frac{\partial\psi(\vec{x}, t)}{\partial t} = -\frac{1}{2m}\nabla^2\psi(\vec{x}, t) \quad (119)$$

→ The phase transformed wavefunction $\psi'(\vec{x}, t)$ is, however, **not** a **solution** of this Schrödinger equation.

- **Gauge principle:** to keep the invariance condition satisfied, a minimal field should be added to the Schrödinger equation, i.e., an **interaction** should be introduced
- This can be done by requiring that the Schrödinger equation should also be invariant under a gauge transformation of the type:

$$\bar{A} \rightarrow \bar{A}' = \bar{A} + \nabla\alpha$$

$$V \rightarrow V' = V - \frac{\partial\alpha}{\partial t}$$

where \bar{A} and V are the vector and scalar potentials of the electromagnetic field in which a particle with charge q is moving.

In order for the free-particle Schrödinger equation to be invariant under both the U(1) phase transformation and the gauge transformation, the equation has to be changed to:

$$i\frac{\partial\Psi(\vec{x}, t)}{\partial t} = \left[\frac{1}{2m}(\vec{p} - q\bar{A}) + qV \right] \Psi(\vec{x}, t)$$

Unification and the gauge principle

In QED, the transition from one electron state to another with a different phase, $e^- \rightarrow e^-$, demands emission (or absorption) of a photon: $e^- \rightarrow e^- \gamma$

More generally, one can define gauge transformations that not only change the phase but also transforms electrons and neutrinos:

$$e^- \rightarrow \nu_e \quad \nu_e \rightarrow e^- \quad e^- \rightarrow e^- \quad \nu_e \rightarrow \nu_e$$

these lead via the gauge principle to interactions

$$e^- \rightarrow \nu_e W^- \quad \nu_e \rightarrow e^- W^+ \quad e^- \rightarrow e^- W^0 \quad \nu_e \rightarrow \nu_e W^0$$

where W^+ , W^- and W^0 are the corresponding spin-1 gauge bosons.

While W^+ and W^- are the well-known bosons responsible for charged currents, W^0 is **not observed** experimentally.

→ This problem is solved by the **unification** of **electromagnetism** with **weak interactions** since this result in that both the Z^0 and the γ are mixtures of W^0 and yet another neutral boson B^0 :

$$\begin{aligned}\gamma &= B^0 \cos\theta_W + W^0 \sin\theta_W \\ Z^0 &= -B^0 \sin\theta_W + W^0 \cos\theta_W\end{aligned}\tag{120}$$

The gauge transformation which achieve this is called a local gauge transformation of the type.

$$U(1) \otimes SU(2)_L$$

The requirement of gauge invariance under this transformation leads to **new vertices**:

$$e^- \rightarrow e^- B^0 \quad \nu_e \rightarrow \nu_e B^0$$

For these vertices the electromagnetic charge has to be replaced with **new couplings** $g_{Z\gamma_e^-}$ and $g_{Z\gamma_{\nu_e}}$

One can show that the new couplings can be chosen such that

$$\gamma = B^0 \cos \theta_W + W^0 \sin \theta_W$$

has the coupling of the photon if the unification condition is satisfied i.e. if

$$\frac{e}{2\sqrt{2}\epsilon_0} = g_W \sin \theta_W = g_Z \cos \theta_W$$

→ **Conclusion:** Electroweak theory can be made **gauge-invariant** by introducing neutral bosons W^0 and B^0 . The Z^0 and γ states that are observed in experiments are **linear combinations** of these.

The Higgs boson

❖ Generally, experimental data agree with gauge invariant electroweak theory predictions.

→ However, gauge invariance implies that the **gauge bosons** have zero masses if they are the only bosons in the theory. Photon in QED and gluons in QCD comply with this but not the Z and W bosons.



a new field should be introduced !

❖ The scalar *Higgs field* solves the problem:

- *The Higgs boson* H^0 is a spin-0 particle
- The Higgs field has a **non-zero** value ϕ_0 in **vacuum** (the field is non-zero in the groundstate).

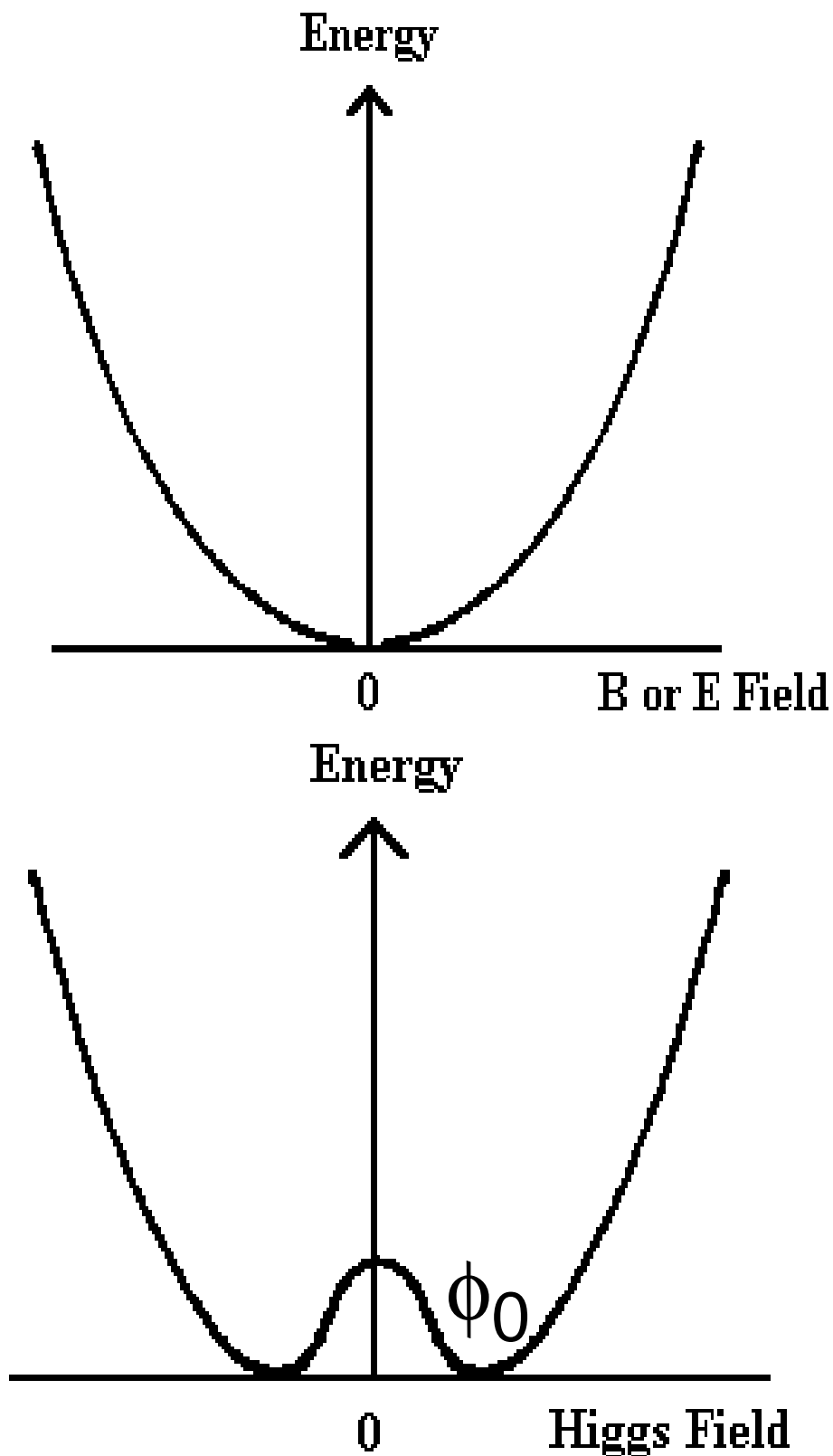

Figure 120: Comparison of the electric and Higgs fields

❖ The interactions of the Higgs field with the gauge bosons is gauge invariant, however, the vacuum value ϕ_0 is not gauge invariant \Rightarrow the interaction has *hidden gauge invariance* (or its symmetry is *spontaneously broken*).

Since the vacuum expectation value is not zero, the vacuum is supposed to be populated with massive Higgs bosons \Rightarrow **when a gauge field interacts with the Higgs field it acquires mass**

The W and Z bosons require masses in the ratio given by

$$\cos\theta_W = \frac{M_W}{M_Z}$$

In the same way, **fermions** acquire masses by interacting with Higgs bosons and the coupling constant is related to the fermion masses:

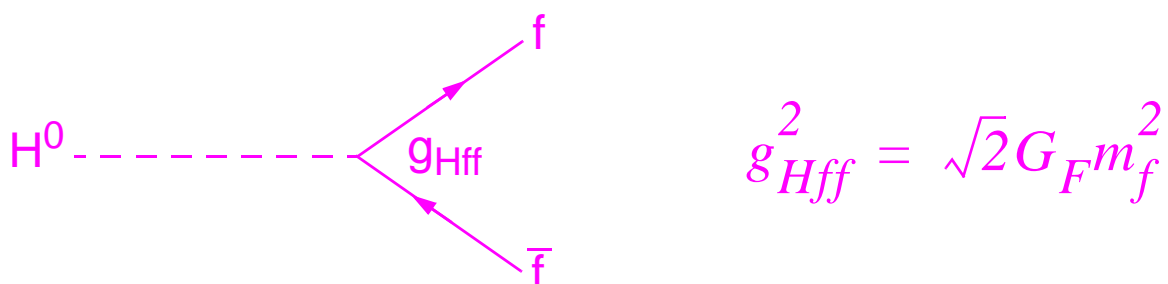

Figure 121: Basic vertex for Higgs-fermion interactions

The search for the Higgs boson

- ❖ The **mass** of the **Higgs** itself is **not predicted** by the theory, only the couplings to other particles.
- ❖ The existence of the Higgs boson has not been confirmed by experiments.

Searches for the Higgs at LEP.

- a) If the **H^0** was lighter than the **Z^0** ($M_H \leq 60$ GeV), then the Z^0 could decay by

$$Z^0 \rightarrow H^0 + l^+ + l^- \quad (121)$$

$$Z^0 \rightarrow H^0 + \nu_l + \bar{\nu}_l \quad (122)$$

But the branching ratio is very low:

$$3 \times 10^{-6} \leq \frac{\Gamma(Z^0 \rightarrow H^0 l^+ l^-)}{\Gamma_{tot}} \leq 10^{-4}$$

The measurements at LEP 1 has set a *lower limit* on the Higgs mass which is **$M_H > 58$ GeV/c²**

b) If the H^0 is heavier than $60 \text{ GeV}/c^2$, it could have been produced in e^+e^- annihilations at LEP 2. The most important process is:

$$e^+ + e^- \rightarrow H^0 + Z^0 \tag{123}$$

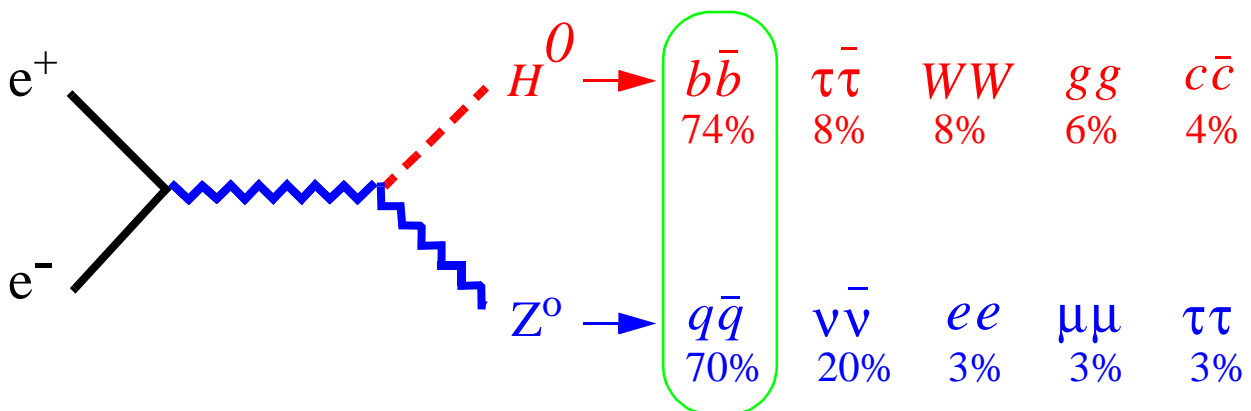

Figure 122: “Higgsstrahlung” in e^+e^- annihilation

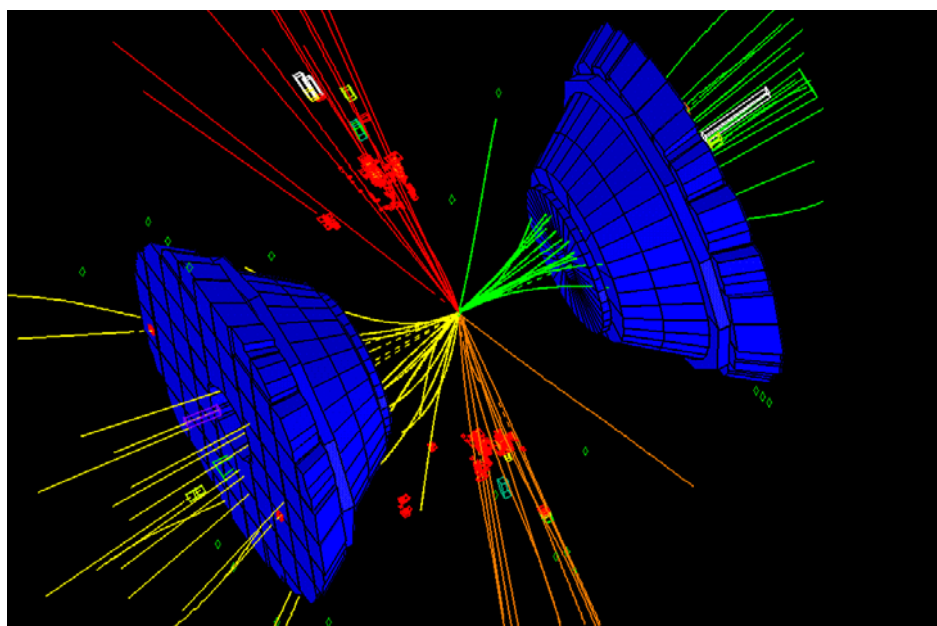

Figure 123: Example of a Higgs candidate event (Delphi).

❖ During the last year of operation of LEP 2, the **ALEPH** experiment recorded a couple of events which **could be** due to the decays of a **Higgs** with a mass of about $115 \text{ GeV}/c^2$. The other LEP experiments could **not confirm** the ALEPH results and the DELPHI experiment set a limit of:

$$M_H > 114 \text{ GeV}/c^2$$

The measurement of many electroweak parameters at LEP (and other places) makes it possible to make a **global fit** with the Higgs mass as a free parameter

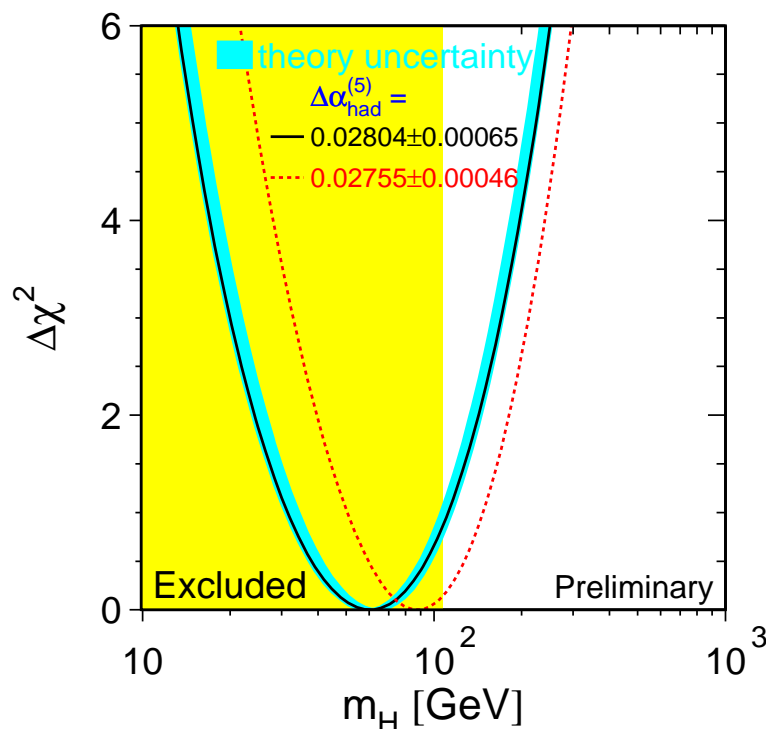

Figure 124: A prediction of the Higgs mass from a global fit to electroweak measurements.

❖ The result of the fit is a prediction of a low **mass** for the Higgs boson **< 165 GeV**.

Searches for the Higgs at LHC.

c) Higgs with masses up to 1 TeV can be observed at the future proton-proton collider LHC at CERN:

$$p + p \rightarrow H^0 + X \quad (124)$$

where H^0 is produced in electroweak interaction between the quarks

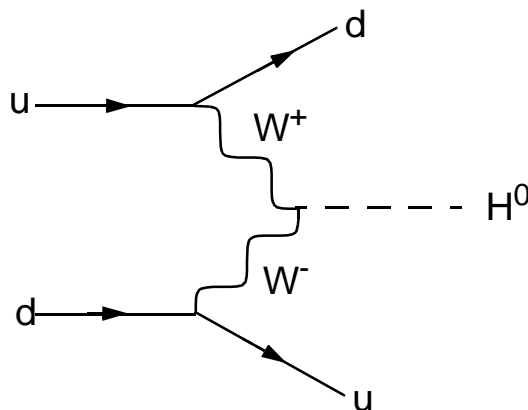

Figure 125: An example of Higgs production process at LHC

At the LHC the background is huge and a good signature have to be found.

– If $M_H < 2M_W$, ($160 \text{ GeV}/c^2$) the dominant decay mode is

$$H^0 \rightarrow b + \bar{b} \quad (125)$$

but these events will be **swamped by background**. A more promising decay mode is

$$H^0 \rightarrow \gamma + \gamma \quad (126)$$

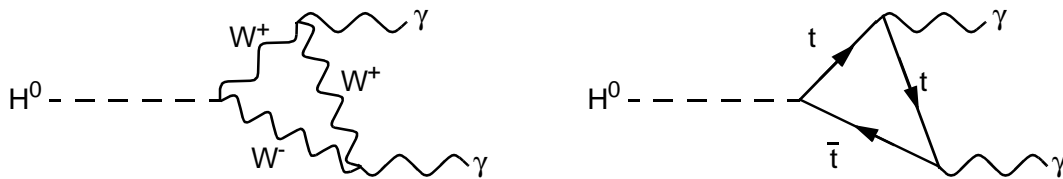

Figure 126: The dominant mechanisms for the decay to photons

The branching ratio of this kind of processes is, however, only 10^{-3}

– If $M_H > 2M_Z$, the dominant decay modes are:

$$H^0 \rightarrow Z^0 + Z^0 \tag{127}$$

$$H^0 \rightarrow W^- + W^+ \tag{128}$$

The **most clear signal** is when both Z^0 s decay into electron or muon pairs:

$$H^0 \rightarrow l^+ + l^- + l^+ + l^- \tag{129}$$

These decays can be found if $200 \leq M_H \leq 600$ GeV, but only 4% of all Higgs particles decay to four electrons or muons.

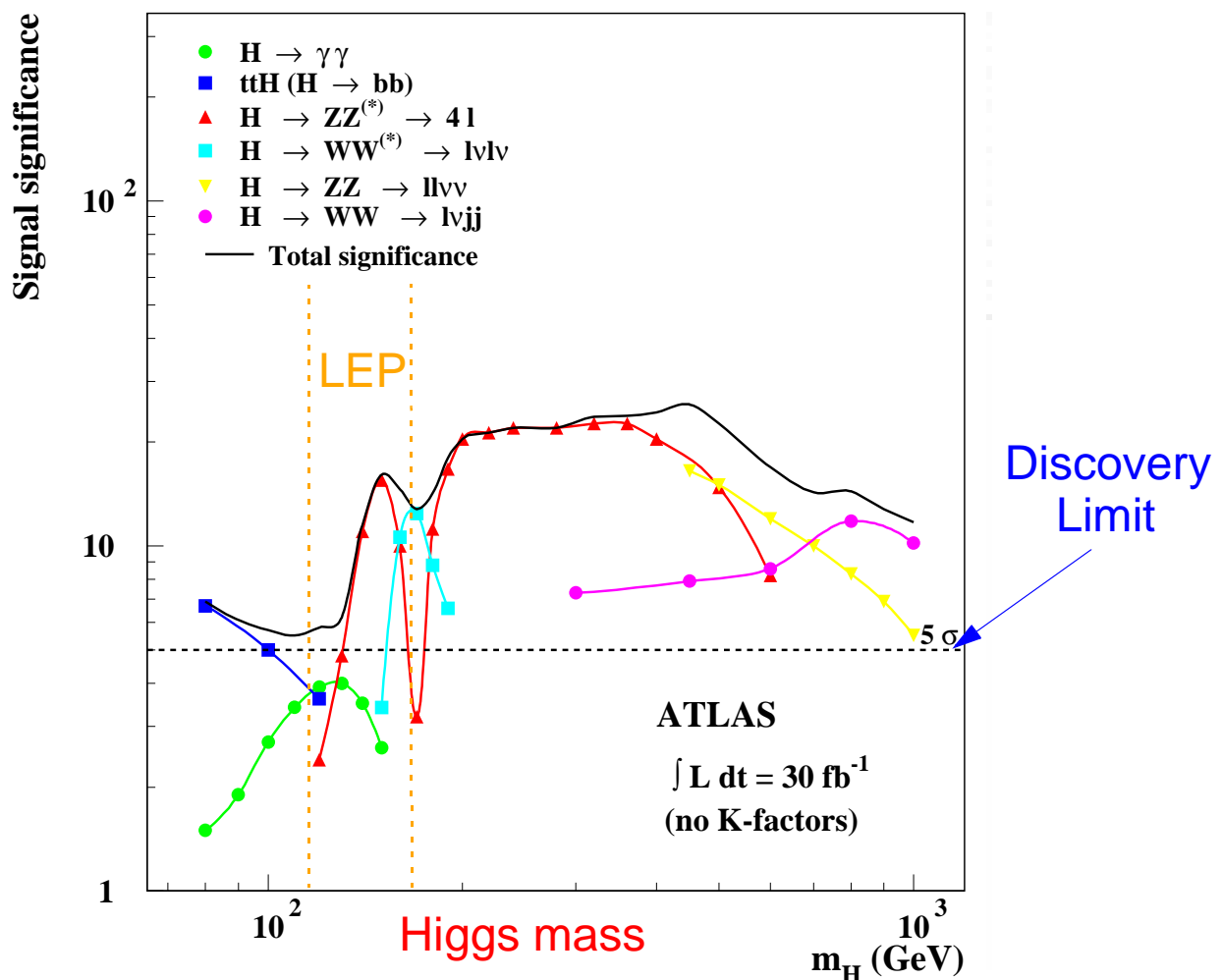

Figure 127: Higgs discovery potential at the LHC.

Summary

• The problem of divergence

- a) By introducing the Z-bosons one can cancel out divergent diagrams from the W-bosons.
- b) There is no quark mixing in Z-vertices.

• Test of flavour conservation.

- c) Kaon decay show that flavour is conserved at a Z-vertex (but not a W-vertex).

• The unification condition and masses.

- d) The unification condition establishes a relation between the electromagnetic coupling constants.
- e) The ratio of the W- and Z-masses is given by the weak mixing angle (the Weinberg angle).

• Electroweak reactions

- f) Fitting the Z-peak gives the mass and width of the Z-boson. From this, it can be determined that the number of light neutrino families is 3.

- **Gauge invariance.**

- g) A gauge transformation is a symmetry transformation.
- h) Field theories which do not change under gauge transformation are gauge invariant.
- i) Imposing gauge invariance on the weak interaction theory leads to the prediction of three massless W -bosons.
- j) The unification of electromagnetism with weak interactions leads to the introduction of the B^0 -boson which is connected to the electromagnetic field.
- k) The neutral gauge bosons that are observed in experiments (γ and Z^0) are mixtures of the B^0 and W^0 states.

- **The Higgs boson.**

- l) The Higgs field and its gauge boson are introduced to explain the large masses of the W - and Z -bosons.

m) The Higgs field has the unusual feature of having a non-zero expectation value in vacuum.

- **The search for the Higgs boson**

n) The LEP experiments have been the main place for the search for a Higgs up to now.

o) In the future the search will take place at the Tevatron followed by the LHC.